



Ergonomic, Configurable Optical Inspection

- Compact modular design with excellent cable management
- Full HD 1080p, 60 frames per second lag-free video with true colours
- Superior 35:1 motorised zoom lens with fast auto-focus and iris-controlled depth of field
- Built-in easy-to-access lens- and camera controls
- Wide range of lenses, lights, and other accessories



"Designed according to industry standards"

Developed for Productivity

First class optics, high magnification and 35x motorised zoom in robust aluminium housing for Full HD optical inspection where and how you need it! Available in two industrial grade form factors, F35 with integrated stand & illumination and F35s modular configurable system.

Inspectis digital microscopes provide relief to eyes, neck and shoulders through the unique ergonomic design, sharp images, built-in laser pointer and 230 mm free

working distance. By allowing operators to sit comfortably in a good working position, their inspection tasks can be carried out more efficiently.



Thanks to its fast optics and large image sensor, F35 provides an excellent image of inspecting object, especially solder joints on electronic PCBs and metallic parts with minimum glare and reflections.

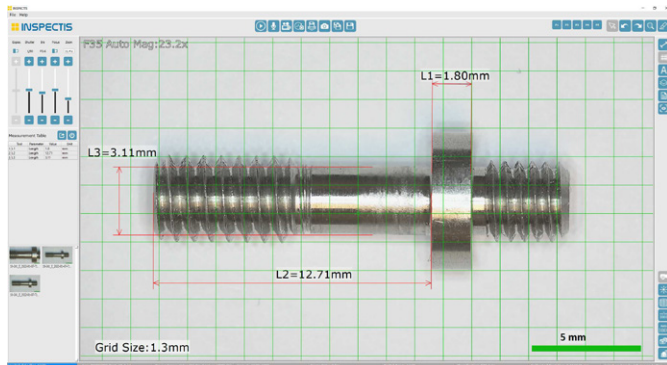

Mechanics, x11.4 Zoom, 23.2x Mag. with INSPECTIS® Pro

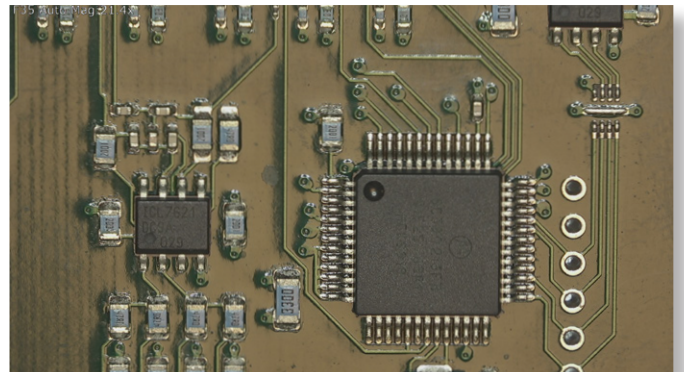

Electronics PCB, 5x Zoom, 8.4x Mag.

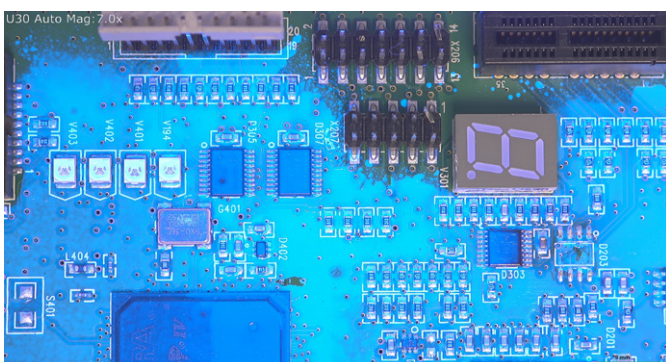

PCB with conformal coating, illuminated by UV ring light



Cabbage seeds, x35 Zoom, 43.3x Mag. with back-light

Precise Camera and Lens Control

Camera and lens attributes such as optical zoom, lens aperture size, focus and colour balance can be adjusted directly by integrated on-board controls, from INSPECTIS© software or via a range of remote control consoles supplied to improve user comfort.



” Full control of camera and lens at your fingertips ”

Designed for Ease of Use

F35 digital microscopes are powered by INSPECTIS® software. Powerful yet easy-to-use live image view, capture, analysis, measurement and reporting software. Tools for direct camera and lens control, 16 memory

presets, zoom tracking, focus stacking, drawings and annotation, image overlays & comparison, time lapse video recording, distortion control and report generator are provided with different functionality levels.

With pre-calibrated F35 optics and its icon based graphical user interface INSPECTIS® is easy-to-use and efficient for different inspection and quality control tasks.

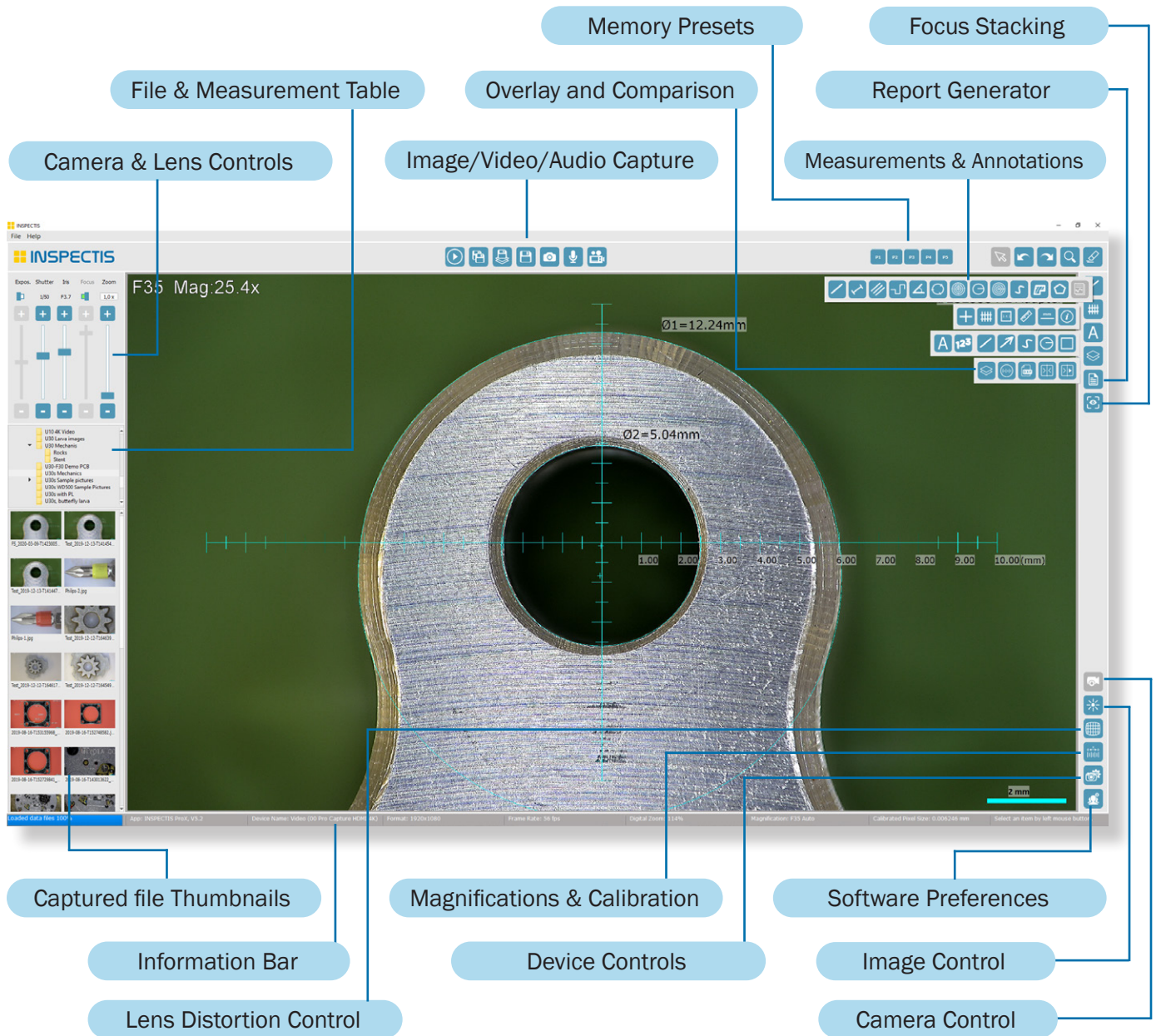

Easy image/video capture and sharing options makes collaboration, reporting and training quick and easy. Thanks to its powerful video processing engine and streamlined workflow, INSPECTIS® reduces time spent on capture, analysis, measurements and documentation of your inspection objects.

“Reduce the time spent on Inspection, Measurements and Documentation”

INSPECTIS© Software level Comparison Table

INSPECTIS© software is supplied in 4 functionality levels, Basics, Pro, OAI and ProX.

Feature	Basics	Pro	OAI	ProX
Live image view, freeze to still image	•	•	•	•
Digital zoom of still and live image	•	•	•	•
Full screen image view	•	•	•	•
Define resolution of captured video	•	•	•	•
Define and calibrate custom magnifications	•	•	•	•
Import and calibrate external images	•	•	•	•
16 Memory pre-sets and recall for camera and lens configurations	•	•	•	•
Direct camera and lens parameters controls	•	•	•	•
Automatic calibration and tracking of the entire zoom range of the camera	•	•	•	•
Automatic lens distortion correction in live image	•	•	•	•
Flip image vertically/horizontally, b/w conversion and enhanced contrast	•	•	•	•
Distance measurement	•	•	•	•
Free-form area, length and perimeter measurements		•		•
Circle, angle, curve length and polygon measurements		•		•
Select, move, adjust, erase, undo/redo measurements and annotations	•	•	•	•
Overlay grids, rectangle and crosshair on live image	•	•	•	•
Annotation and objects counts on Image	•	•	•	•
Drawing tools like rectangle, ellipse, curve, line and arrow		•	•	•
File folder system management	•	•	•	•
Save multiple frames to one picture	•	•	•	•
Add comments linked to images	•	•	•	•
Print images	•	•	•	•
Send files by email	•	•	•	•
Multilanguage interface	•	•	•	•
Password for supervisor lock software preferences and camera settings	•	•	•	•
Calibration tracking error compensation	•	•	•	•
Generate reports and certificates with images and measurements	•	•		•
Automatic Barcode, QR and Datamatrix scanner and Excel report			•	•
Record video and audio		•		•
Auto snap to measurement lines, ends, corners and centres		•		•
Export performed measurements (TXT and EXCEL)		•		•
Overlay 2-dimensional mm/µm scales on live image		•	•	•
Overlay semi-transparent picture on live image		•	•	•
Compare live to still or still to still images		•	•	•
Automatic object counting				•
Automatic and manual focus stacking (dept of field extender)				•
Time lapse video capture and recording			•	•
Time interval Overlay Assisted Inspection (OAI)			•	•
Optical edge detection and DXF export			•	•
DXF new, import, edit and export			•	•
Drawing toolbox for DXF			•	•
PNG export of DXF files			•	•
DXF overlay on live image			•	•
PNG overlay on live image as digital graticule			•	•
Automatic alignment of overlaid image to live image			•	•
Automatic rescaling of overlaid image through lens zoom			•	•

System Configurations

HD-113-KIT-ADV, Inspectis F35s Advanced, FHD Inspection System

Included items:

- Inspectis F35s, Full HD 1080, 60p Modular Digital Inspection Macroscope, x35 Zoom
- Track stand, Large Base with focusing WD 35-410mm, ESD-Protected base
- XY Floating Board with magnetic pegs (4x kit)
- RingLight White LED with detachable diffuser
- FHD USB3.0 Capture with INSPECTIS® Pro software and USB-COM Cable
- Annual Service and Support for INSPECTIS® Pro (one year)



Monitor and keyboard are illustrative and not included

HD-112-KIT-SOFT, Inspectis F35, All-in-One FHD system with Software

Included items:

- Inspectis F35s, Full HD 1080p Modular Digital Inspection Macroscope, x35 Zoom
- Full HD USB3.0 Capture with INSPECTIS® Basics software and USB-COM cable
- Annual Service and Support for INSPECTIS® Basics (one year)



Monitor and keyboard are illustrative and not included

Optional Accessories



- HD-036, Macro lens +1 diopter, 67mm
- HD-037, Macro lens +2 diopter, 67mm
- HD-038, Macro lens +3 diopter, 67mm
- HD-039, Macro lens +5 diopter, 67mm
- HD-142, High Magnification lens +28 diopter
- HD-143, High Magnification lens +56 diopter



INSPECTIS® ProX
Image Capture, Measurement, Analysis
& Documentation with Advance Utility Features

-PX, Upgrade INSPECTIS® Pro software to INSPECTIS® Pro-X



- HD-051, USB Foot switch 1-pedal
- HD-052, USB Foot switch 3-pedals



- HD-020, Advanced Remote Control
- HD-020-L, Advanced Remote Control with LP control



- HD-200, Remote Control with Knob Drive
- HD-200-MEM, Remote Control with Knob Drive Programmable 7 memories Drive



- HD-24-B, RingLight White LED with diffuser
- HD-25-B, RingLight UV LED, $\lambda=365\text{nm}$



- HD-24-P-U, Polarisation filter set for Ring Light, 67mm (for U and F models)



- HD-126, Double-Spot LED matrix light with gooseneck



- HD-127-EU, Backlight, brightfield transmitted (EU-cable)



- HD-029, Tilt Board



- HD-028, XY Floating Board
- HD-028-L, XY Floating Board with position lock

"Configurable with different stages and lighting options"

System Configurations

HD-113-KIT-SOFT, Inspectis F35s Capture, FHD Inspection System

Included items:

- Inspectis F35s, Full HD 1080p Modular Digital Inspection Microscope, 35x zoom
- Inspectis Single-arm Boom Stand
- Inspectis Single-Spot LED matrix light with gooseneck
- Inspectis Full HD HDMI USB3.0 Capture with INSPECTIS© Basics software
- Annual Service and Support for INSPECTIS© Basics (one year)

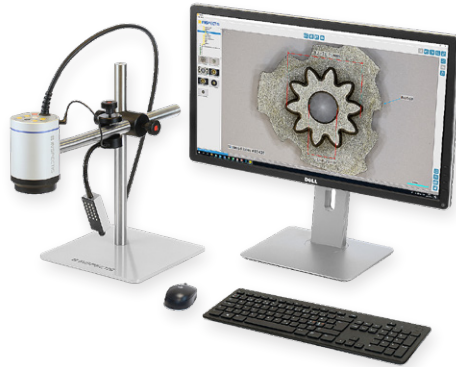

Monitor and keyboard are illustrative and not included

HD-113-KIT-CAP, Inspectis F35s Capture, FHD Inspection System

Included items:

- Inspectis F35s, Full HD 1080p Modular Digital Inspection Microscope, 35x zoom
- Inspectis Single-arm Boom Stand
- Inspectis Single-Spot LED matrix light with gooseneck
- Full HD External Image Capture and Video Recorder for F microscopes
- 23"-24" Full HD LCD monitor



HD-113, Inspectis F35s Modular Digital Microscope



Modular design of F35s allows easy configuration of your optical inspection system with a wide range of stands and mounts.

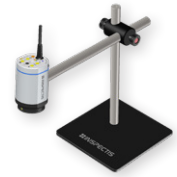

HD-060, Single-arm Boom Stand
HD-060-E, Single-arm Boom Stand, Antistatic



HD-071, Double-arm Boom Stand, Light
HD-071-E, Double-arm Boom Stand, Light, Antistatic

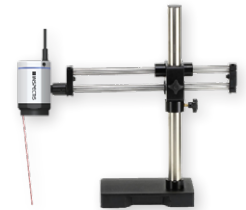

HD-070, Double-arm Boom Stand with Heavy-Duty Base



HD-080, Articulated-arm Boom Stand with Bench-top Clamp



HD-081, Articulated-arm Stand 3-axis with Bench-top Clamp



HD-170, XY-travel Stand, In-line



HD-180, XY-travel Stand, Table-top

"Modular F35s available with 500mm and 1000mm WD"

Optical Data

The system's standard optics with 1.7 - 61.4x magnification (24" monitor) surpasses common inspection microscopes. If further magnification is needed, a wide range of extra lenses can be added to magnify up to 720x magnification.



Lens	Zoom Factor	Magnification On-screen	Magnification Optical	Field of View [mm]	Working Distance [mm]	Calibrated Pixel size [μm]	Resolving Power [LP/mm]
Standard	x1	1.7 x	0.7 x	298	> 228-178	155.4 μm	2
Standard	x2	3.4 x	1.4 x	152	> 228-178	79.2 μm	5
Standard	x3	5.1 x	2.0 x	103	> 228-178	53.6 μm	7
Standard	x4	6.7 x	2.7 x	77	> 228-178	40.3 μm	10
Standard	x5	8.4 x	3.4 x	62	> 228-178	32.1 μm	12
Standard	x10	17.2 x	6.9 x	30	> 228-178	15.8 μm	23
Standard	x15	25.9 x	10.5 x	20	> 228-178	10.5 μm	36
Standard	x20	34.2 x	13.8 x	15.2	> 228-178	7.9 μm	40
Standard	x25	43.3 x	17.5 x	12.0	> 228-178	6.3 μm	40
Standard	x30	51.3 x	20.7 x	10.1	> 228-178	5.3 μm	40
Standard	x35	61.4 x	24.8 x	8.5	> 228-178	4.4 μm	40
+1	x35	76 x	30.7 x	6.9	188-145	3.6 μm	40
+2	x35	89 x	36.0 x	5.8	159-128	3.04 μm	64
+3	x35	106 x	42.7 x	4.9	130-108	2.56 μm	80
+5	x35	134 x	54.0 x	3.9	100-75	2.03 μm	102
+10	x35	197 x	79.5 x	2.6	65-60	1.38 μm	144
+28	x10	118 x	47.8 x	4.39	> 18-16.5	2.29 μm	180
+28	x35	425 x	171.4 x	1.22	18-16.5	0.64 μm	256
+56	x10	200 x	80.8 x	2.60	> 18-17.5	1.35 μm	256
+56	x35	720 x	290.9 x	0.72	18-17.5	0.38 μm	362

* On-screen magnifications are based on 24" monitor

"Fast optics with superior resolution power at entire field of view"

Mechanical Dimensions

HD-113-KIT-ADV:

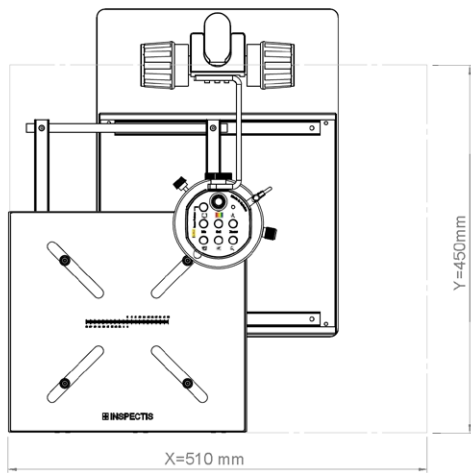

Working Area

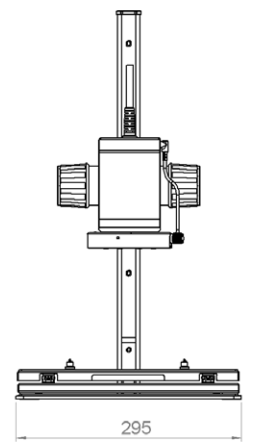
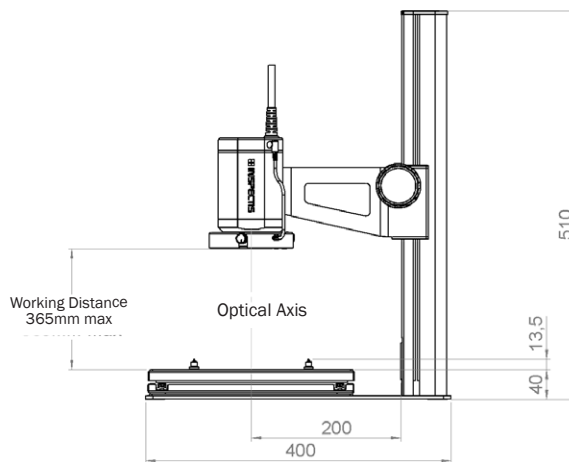

Dimensions in mm

HD-113-KIT-CAP and HD-113-KIT-SOFT:

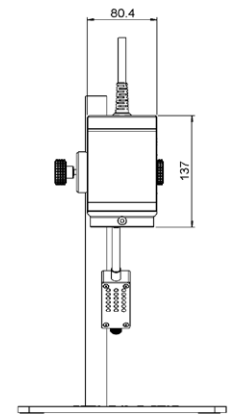
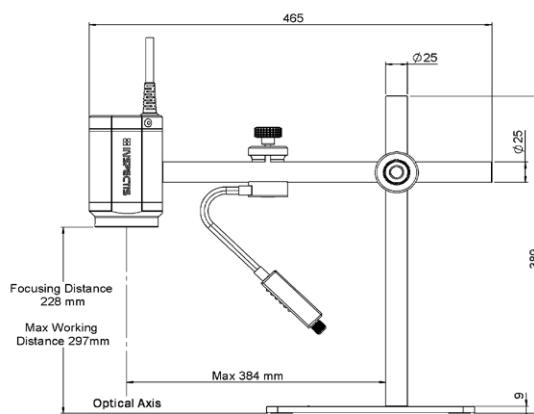
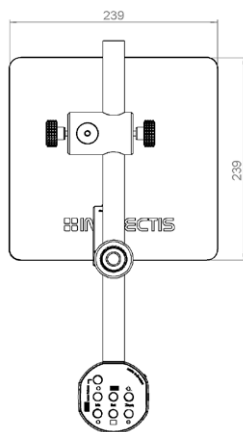

HD-112 and 112-KIT-SOFT:

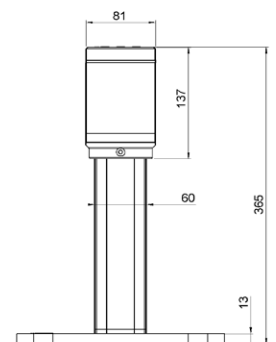
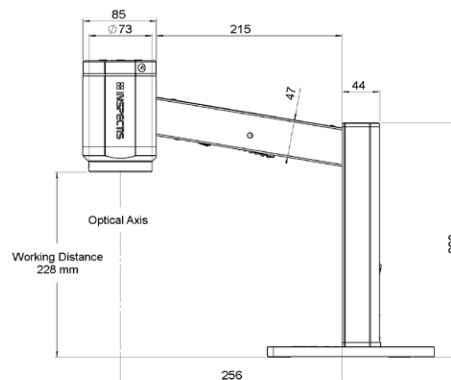
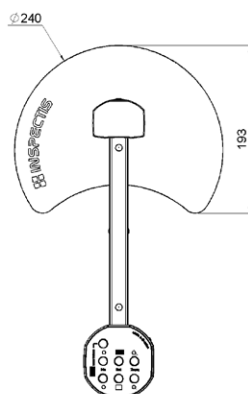

Specifications

Digital Camera System:

Parameter	Value
Video Output	Full HD 1080p/60 frames per second
Image sensor	1920(H) x 1080(V) 16:9 format, 1.62 µm x 1.62 µm pixel size
I/O Ports	HDMI video output, 5P MiniDin Power input, 8P MiniDin for communication
Onboard Control	Zoom, Iris, Auto Focus on/off, Auto Brightness on/off, White Balance
External Remote Control (optional)	Zoom, Iris, Manual/Auto Brightness, Manual/Auto Focus, White Balance, Picture Quality Mode, Display Text, Crosshairs overlay, Image Rotate, Image Freeze, Memory Save/Recall (2 pcs), Foot-switch, Video Output Frame Rate
Illumination F35	Built-in LED matrix light. Optional LED RingLight.
Illumination F35s (optional)	LED RingLight, Single-Spot or Double-Spot LED matrix light with gooseneck
Storage Environment	-20° – +60°C, 20 - 95% RH, non-condensing
Operating Environment	-5 ° – +40°C, 20 - 95% RH, non-condensing
Size, Weight F35	395 x 240 x 360 mm including metal base, 4.5 kg. including metal base
Size, Weight F35s	φ 86.5 x 137mm exclusive cable. 1.1 kg. excluding stand

Ordering numbers Inspection systems packages:

Item name	Order No.
Inspectis F35s, Full HD 1080p Digital Macroscopic, Modular, HDMI	HD-113
Inspectis F35s Advanced, FHD digital Inspection System with Pro Utility and Metrology Software	HD-113-KIT-ADV
Inspectis F35s Software, FHD Inspection System with INSPECTIS Basics software	HD-113-KIT-SOFT
Inspectis F35s Capture, FHD Inspection System, Digital Image/Video Capture and monitor	HD-113-KIT-CAP
Inspectis F35, Full HD 1080p Digital Macroscopic, Integrated Stand, LED, HDMI	HD-112
Inspectis F35, Full HD, 35x zoom, All-in-One with USB3.0 PC Capture and INSPECTIS© Basics	HD-112-KIT-SOFT
Inspectis F35, Full HD, 35x zoom, All-in-One with External USB Capture and Monitor	HD-112-KIT-CAP
Upgrade with Antistatic housing	* -E
Upgrade with Hermetic Sealed Housing	* -S
Upgrade with Laser Pointer	* -L
Upgrade with 3m Extended Cable	* -EC



Reseller:

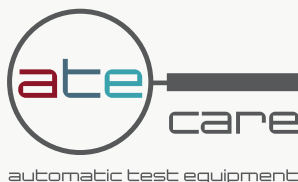

Germany
ATÉcare Service GmbH & Co. KG
 Kirchbergstrasse 21
 D - 86551 Aichach

+49 8131 318 575 120
 info@atecare.com

www.atecare.de

Switzerland
ATÉcare Alexander Hoertner
 Friedhofweg 5
 CH - 9434 Au SG

+41 71 740 10 90
 info@atecare.net



INSPECTIS

Quality of Inspection

Inspectis Optical Systems
 Stockholm, Sweden

www.inspect-is.com
 info@inspect-is.com