

Side-view Optical BGA Inspection System

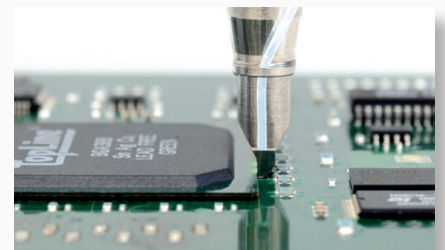

Premium imaging quality for fast and flexible inspection, measurement, and documentation of hidden solder joints of BGA, μ BGA, FlipChip, CSP, CGA and SMD components.

- High-resolution visual inspection system with 5.0MP digital microscope and USB3.0 interface
- Interchangeable 90° side-view varifocal BGA lenses with integrated stereo lighting
- Interchangeable 8-80x varifocal lens for top-view PCB/SMD inspection
- Fibreoptics transmitted background illumination with high-power LED light
- Microprism transmitted background illumination with built-in LED light
- Stand with soft-touch mechanism for protecting the optical probe tip
- Stand with $\pm 90^\circ$ pivoting bracket for axial rotation of the optical lens
- Precision XY-stage with quick-feed micrometre drives and magnetic pegs
- Including INSPECTIS© image capture, measurement and utility software



Designed for Productivity!



Developed for Productivity

The Inspectis BGA inspection system features the tiniest optical probe with high-resolution optics, built-in lighting, 5.0 megapixel image sensor and high power background illumination mounted on a compact robust stand with XY-translation stage.

The Inspectis BGA system produces high-resolution images of the extremely low-clearance areas beneath BGAs, μ BGAs, CSP, CGA and FlipChip packages with as low as 40 microns stand-off.



Variable focus capability of the optics with a flexible, electronically dimmable incident microprism and background fiber optics lightings allows the user to image from first to up to 20 rows of BGA solder bumps.

The unique soft-touch mechanism design in the stand bracket protects the microprisms in the optical probe tip from damage when positioned on surface of the inspection PCB.

The built-in $\pm 90^\circ$ pivoting mechanism allows alignment of the probe along 3 different sides of the BGA package.

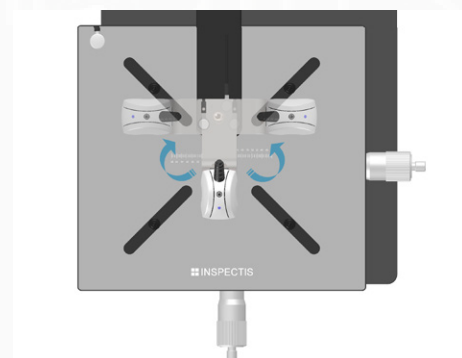

Inspection system available in 2 system levels **Basics** and **ProX**

Designed for Flexibility

Find micro-cracks, cold solder joints, whisker, missing balls, scaling, excess flux and other soldering issues.

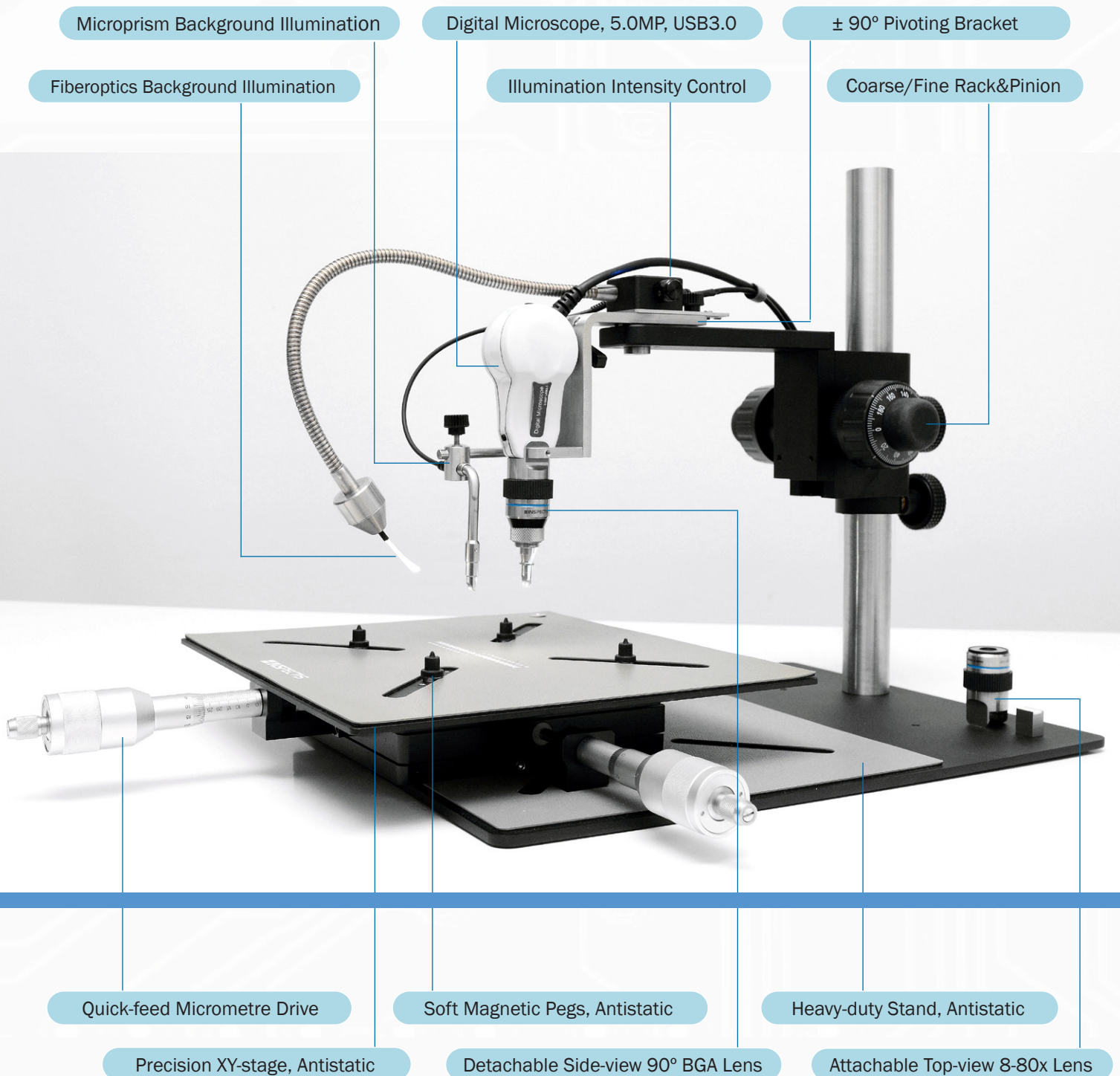

Thanks to its interchangeable side-view and top-view optics the Inspectis BGA system provides a flexible and versatile inspection solution for efficient use of investment budget for all post-production or R&D optical inspection tasks.



Developed for Productivity

The system is supplied with INSPECTIS® software. Powerful yet easy-to-use live image view, capture, analysis, utility, and metrology software.

INSPECTIS® provides powerful tools for calibration of magnification, live image overlays, comparison, focus stacking, image stitching, annotations and reporting.

Available in two functionality levels, INSPECTIS® Basics and INSPECTIS® ProX for side-view BGA and top-view PCB optical inspection.

Icon-based User Interface

The screenshot shows the INSPECTIS software interface with several key components labeled:

- Measurement Table**: Located at the top left, displaying a table with columns for Tool, Parameter, Value, and Unit. It lists two items: 1. DI1 Diameter 671.68 um and 2. DIA Area 0.1543 mm².
- Camera Controls**: A panel on the left side containing various camera adjustment sliders and buttons.
- Drawing tools & Annotations**: A toolbar at the top center with icons for drawing and annotation.
- Image/Video/Audio Capture**: A toolbar at the top center with icons for capture and recording.
- Measurements**: A toolbar at the top right with icons for measurement and analysis.
- Overlay & Compare tools**: A toolbar on the right side with icons for overlay and comparison.
- Pictures & files Thumbnails**: A vertical strip on the left side showing a grid of image thumbnails.
- Camera Controls**: A panel on the left side containing various camera adjustment sliders and buttons.
- Magnifications & Calibration**: A panel at the bottom center with a scale bar and calibration information.
- Program Preferences**: A panel at the bottom right with icons for settings and preferences.
- Image Control**: A panel at the bottom right with icons for image processing and control.

Thanks to its powerful video processing engine, user-friendly icon-based interface and streamlined workflow, INSPECTIS® software reduces time spent on capture, analysis, measurements, and documentation of your inspection tasks.

Software available in 2 functionality levels **INSPECTIS® Basics** and **ProX**

Effortless Navigation and Operation

INSPECTIS© software is designed to help users navigate effortlessly. With a logical layout and graphical icons for each function, operators can quickly become familiar with the software, saving time during inspection and measurement routines and reducing the need for training sessions.

Icon-based Function Tools

Image, Video, Audio Capture



Live/Freeze, Save Image as, Save Averaged Frames, Save Image field, Capture image, Record Audio, Record Video

Measurement tools



Distance, Poly-line, Angle, Circle, Concentric Circles, Free-form curve, Area and Polygon Measurements

Crosshair, Grid & Graticule



Crosshair, Grid, Rectangle, 2D Ruler, and Reference Scale on Live Image

Compare & Image Overlay



Edge Detection and DXF Editor

Digital Graticule, Compare Still Images, Compare Live, Semitransparent Overlay. Optical Edge Detection and DXF Editor

Image/lens Calibration



Automatic and Manual Calibration of Lens Magnifications

Annotation & Count



Drawing

Annotations and Object Count. Draw and edit Line, Arrow, Curve, Circle, Rectangle, and Triangle on Image

Interval Overlay with Timer



Interval Overlay of Live Image on Reference Picture with Time Frequency Control

Focus Stacking



Focus Stacking, Clear Images, Load External Images, Enhanced Focus Stacking Filter

Camera Control



Camera presets

2 Preset and 2 Custom made Camera Configurations in Memory for Quick Recall

Please check software version for feature availability.



INSPECTIS[©] Basics for BGA

Besides digital camera control and setup, tools such as overlay grids, rectangle and crosshair on live image, annotation on captured image and contrast enhancement are available.

INSPECTIS[©] is an easy to use yet powerful software when digital image acquisition and documentation are primary requirements.

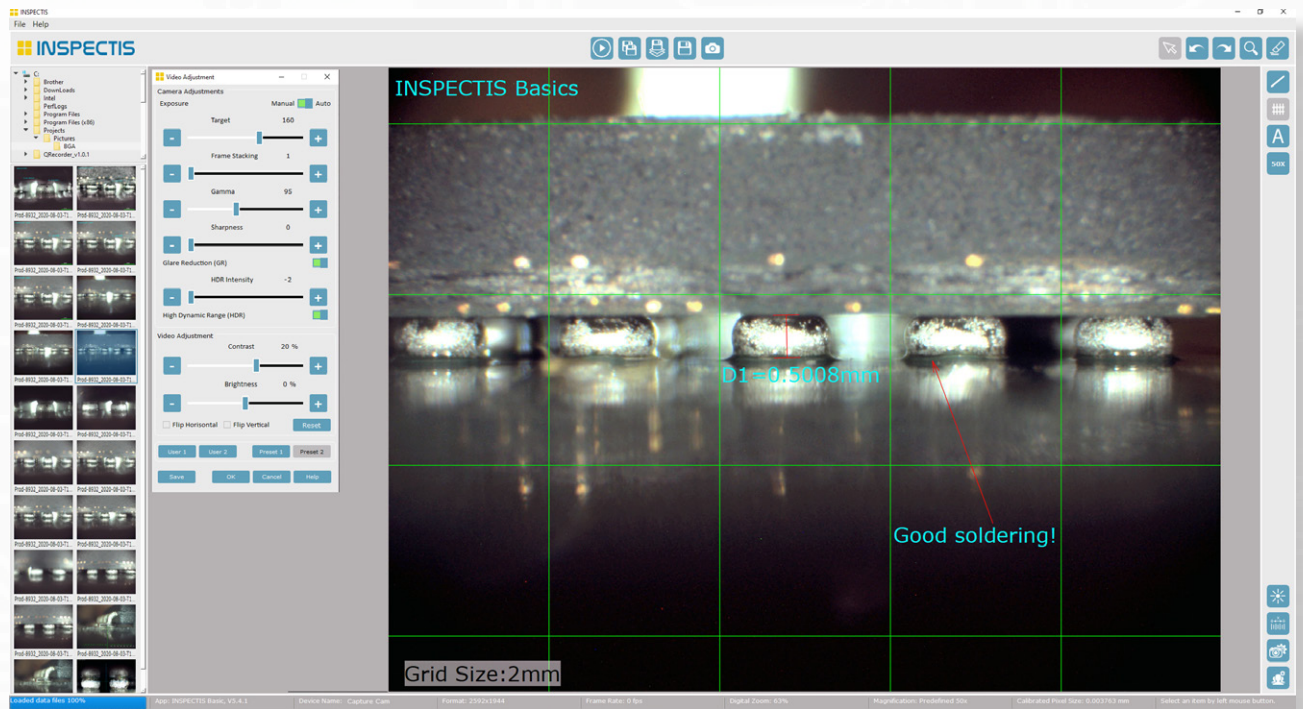

An easy-to-use visual inspection and documentation solution!



BGA bumps (large field of view)



BGA bump (high magnification)

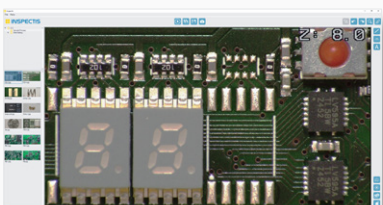

Top view PCB (with 80x lens)

INSPECTIS[©] Basics Highlights

- Real-time digital camera setup and parameter controls
- Memory preset and quick recall buttons
- Live image view, capture, save and save as
- Digital zoom, pan and flip of still and live image
- Full screen image view
- Calibrate lens magnifications
- On-screen distance measurement
- Annotations and feature markup tools
- Objects count on image
- Write comments and link to each picture
- Crosshair, grid and rectangle overlay on live image
- Change font, size and colour
- Contrast adjustment and enhanced contrast
- Generate reports with images and measurements
- Print files or send by email
- 3 installations with one license
- Multilanguage interface

INSPECTIS[©] ProX for BGA

Powerful image view, capture, analysis and metrology software. A wide range of utility functions such as direct camera control, memory presets, comprehensive measurement tools, image compare, image stitching,

focus stacking and overlay assisted functions are available. Advanced software when optical inspection, image analysis, measurement, and reporting are the requirements.



A complete analysis, measurement, documentation and reporting solution!



INSPECTIS[©] ProX Highlights

In addition to Basics:

- Powerful set of geometry measurement tools
- Record video and audio
- Focus stacking for depth of field extension
- Image stitching with crop function
- Snap function for easy selection of geometry points
- Auto-creation of measurement table for data reporting
- Export measurements data to Excel file
- Auto-creation of reports and certificates
- Compare live to still or still to still images
- Overlay semi-transparent picture on live image
- Overlay 2-dimensional mm/ μ m scales on live image
- Overlay digital graticule on live image
- DXF import, edit and overlay tools
- Time interval Overlay Assisted Inspection (OAI)
- PNG overlay on live image as digital graticule

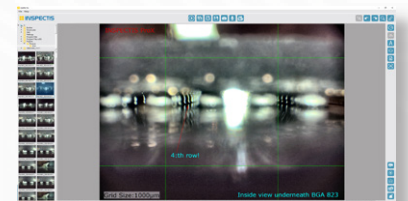

Inner rows of BGA bumps

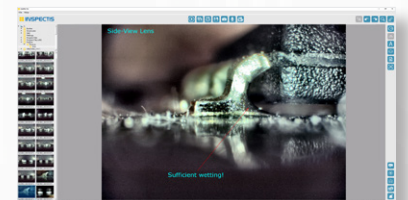

Wetting of the SOP pins

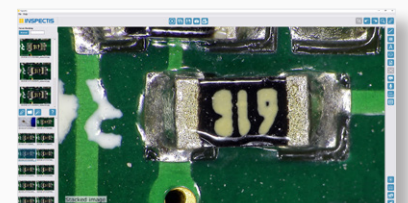

Assembled PCB (focus stacked)

Advanced Features of INSPECTIS[©] ProX

Focus Stacking

Create images with extended depth of focus by taking multiple images at different focus depths to create one ultra-sharp image.

Focus Stack

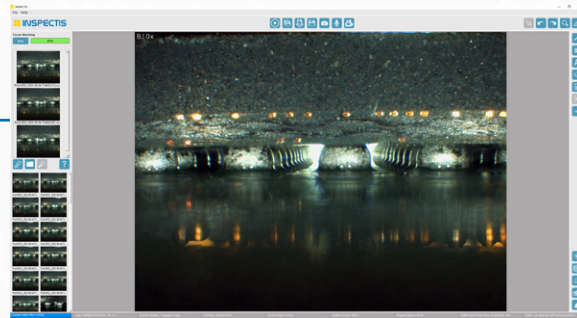

Compare Windows

Compare live image to a reference picture or compare 2-4 still images to each other. Used with both side-view and top-view lenses.

Compare Window

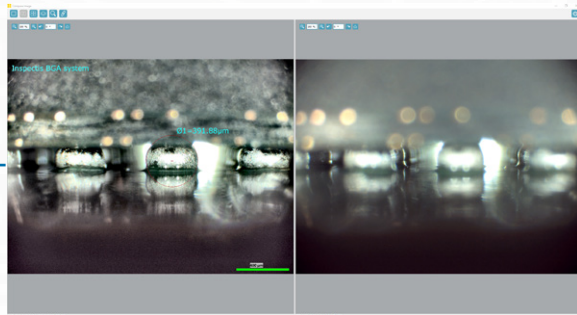

Overlay Assisted Inspection

Overlay live image on a reference picture with timer-controlled interval display. An efficient tool for identifying missing components, wrong polarity, misplacements, and other defects on assembled PCBs when inspected with top-view varifocal lens.

Overlay Assisted Inspection

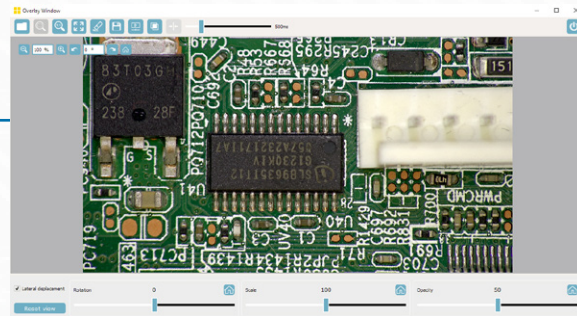

DXF editor and Overlay

Create reference geometry patterns and annotations using DXF editor of the software and overlay the result as Digital Graticule on live image. Open an existing DXF CAD file, edit, and overlay it on live image. A useful tool for quick qualification of components, parts, bare boards, etc when inspected with 8-80x top-view varifocal lens.

DXF Editor and Overlay

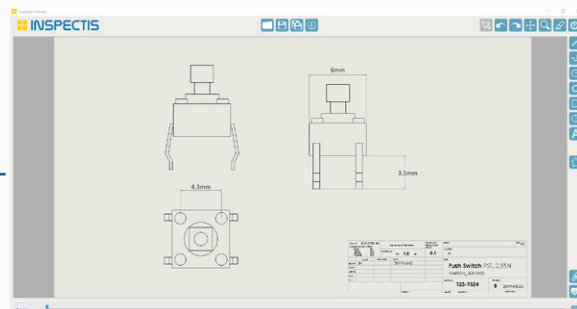

Data Reporting and Certificate tools

Measurement Data:

Data table is generated automatically and linked to the measured image. Results can be exported to Excel or other programs.

Measurement Table				
	Tool	Parameter	Value	Unit
1	L1	Length	10.7	mm
2	Ø1	Diameter	1.5498	mm
3	Ø1A	Area	1.89	mm ²
4	Ø2	Diameter	1.5426	mm
5	Ø2A	Area	1.87	mm ²
6	L2	Length	5.09	mm
7	α1	Angle	90.1	°
8	CA1	Area	1.25	mm ²
9	CL1	Perimeter	6.04	mm
10	PA1	Area	6.96	mm ²
11	PL1	Perimeter	10.86	mm
12	PA2/PA1	Ratio	64.3	%
13	PA2	Area	10.82	mm ²

Data Export



Measurement Data Table

Report and Certificate:

Software includes a report and certificate generator with user-defined templates. Measurement data and comments are automatically imported with selected images.

Customised Templates

Cover Summary Page

Image Summary

Report Pages with Data

INSPECTIS
Quality of Inspection

BGA Solder test of PCB #49232
For customer Selectronic Inc.

Geilgätsvägen 5
171 48 Solna, Sweden
Phone: +46 (0)8-270191
Info@inspect-is.com
www.inspect-is.com

ID: #19232
Date: 2020-08-04
Name: Susan Smith
Notes: Optical inspection of BGA solder quality. Batch 1, 04/08/2020.

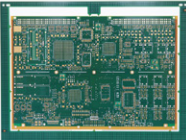

Signature
Susan Smith



Comparison table INSPECTIS[©] **Basics** and **ProX**

Software Functions	Basics	ProX
Real-time digital camera setup and parameter controls	•	•
Digital camera memory presets and quick recall buttons (2 factory set and 2 editable)	•	•
Live image view, capture, save and save as	•	•
Save multiple frames to one picture	•	•
Digital zoom of still and live image	•	•
Full screen image view	•	•
Adjust device properties and device resolution	•	•
Calibrate lens magnifications	•	•
Calibrate images	•	•
Contrast adjustment and enhanced contrast	•	•
Flip image vertically/horizontally	•	•
Black and white conversion	•	•
Distance measurement	•	•
Annotations on Image	•	•
Objects count on image	•	•
Select, move, adjust, erase, undo/redo measurements and annotations	•	•
Overlay grids, rectangle and crosshair on live image	•	•
File folder system management	•	•
Open/save images with calibration	•	•
Add comments to saved images	•	•
Generate reports and certificates with images and measurements	•	•
Print images	•	•
Send files by email	•	•
Multilanguage interface	•	•
Record video and audio		•
Automatic calibration of lens magnifications		•
Free-form area, length and perimeter measurements		•
Circle, angle, curve length and polygon measurements		•
Automatic snap to measurement lines, ends, corners and centres		•
Export performed measurements (TXT and EXCEL)		•
Overlay 2-dimensional mm/ μ m scales on live image		•
Overlay semi-transparent picture on live image		•
Compare live to still or still to still images		•
Focus stacking (focus extender)		•
Image stitching with crop function		•
Time interval Overlay Assisted Inspection (OAI)		•
Optical edge detection and DXF export		•
DXF new, import, edit and export		•
Drawing toolbox for DXF		•
PNG export of DXF files		•
DXF overlay on live image		•
PNG overlay on live image as digital graticule		•
Automatic alignment of overlaid image to live image		•
Automatic rescaling of overlaid image		•



System Configurations and Accessories

BGA-002, Inspectis **ProX** BGA Inspection System

Included items:

- Digital Microscope, 5MP, USB3.0 interface
- INSPECTIS© ProX BGA Inspection software
- Inspectis interchangeable 90° side-view BGA inspection lens
- Inspectis interchangeable 80x top-view varifocal lens
- Fiber Optics Background Illumination Unit with High-power LED and electronic dimmer
- Microprism Background Illumination Unit with LED light source
- Stand with Rack&Pinion, soft-touch and pivoting bracket for BGA microscope
- Precision XY-stage with antistatic mat and magnetic pegs (4x)
- Aluminium Carrying Case for digital microscope, BGA lens and illumination
- Inspectis USB Foot switch for INSPECTIS© Software, 1-pedal



Monitor is illustrative and not included

BGA-001, Inspectis **Basics** BGA Inspection System

Included items:

- Digital Microscope, 5MP, USB3.0 interface
- INSPECTIS© Basics BGA Inspection software
- Inspectis interchangeable 90° side-view BGA inspection lens
- Fiber Optics Background Illumination Unit with High-power LED and electronic dimmer
- Stand with Rack&Pinion, soft-touch and pivoting bracket and magnetic pegs (4x)
- Aluminium Carrying Case for digital microscope, BGA lens and illumination



Computer is illustrative and not included

One year support and free upgrades for INSPECTIS© software is included with all kits

BGA Lenses and Probe Tips



BGA-007, Interchangeable 90° side-view optical probe, small size (spare part)



BGA-006, Interchangeable 90° side-view optical probe, standard size (spare part)



BGA-007, Interchangeable 90° side-view optical probe, small size (spare part)

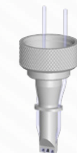

BGA-006, Interchangeable 90° side-view optical probe, standard size (spare part)

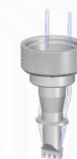

BGA-006, Interchangeable 90° side-view optical probe, standard size (spare part)

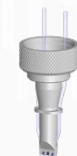

BGA-006, Interchangeable 90° side-view optical probe, standard size (spare part)



BGA-018, Aluminium Carrying Case for digital microscope, BGA lens and illumination

System Configurations and Accessories

BGA-003, Inspectis **Light** BGA Inspection System

Included items:

- Digital Microscope, 5MP, USB3.0 interface
- INSPECTIS© Basics BGA Inspection software
- Inspectis interchangeable 90° side-view BGA inspection lens
- Inspectis Bench-top Holder for Digital Microscope
- Inspectis USB Foot switch for INSPECTIS© Software, 1-pedal
- Aluminium Carrying Case for digital microscope, BGA lens and illumination



Computer is illustrative and not included

Premium side-view BGA inspection system, designed for fast and reliable optical inspection, analysis and documentation of hidden solder joints of BGA, μ BGA, FlipChip, CSP, CGA and top-view SMD components.



Optional Accessories



INSPECTIS© ProX

DM-026, INSPECTIS© ProX BGA Inspection software



HD-051, USB Foot switch for INSPECTIS Software 1-pedal



BGA-011, Microprism Background Illumination



BGA-012, Fiber Optics Background Illumination



BGA-014, Interchangeable fiber brush-light probe (spare part)



DM-036, Inspectis Bench-top Holder for Digital Microscope



DM-012, Precision XY-stage with antistatic mat and magnetic pegs

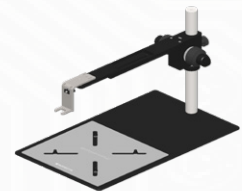

BGA-015, Stand with Rack&Pinion, soft-touch and pivoting bracket for BGA



BGA-017, Flight Case with foam inlay for BGA ProX inspection system equipment



BGA-018, Aluminium Carrying Case for digital microscope, BGA lens and illumination



Specifications



System:

Imager	1/2.5" CMOS, Colour 5 million Pixels.
Pixel Size / Resolution	2.2 µm x 2.2 µm / 2592(H) x 1944(V) pixels
Interface	USB3.0 / USB3.1 Gen 1 (backwards compatible with USB 2.0)
Video Formats @ Frame Rate	2592x1944 (5MP) @15fps, 2000x1500 (3MP)@24fps, 1920x1080 (Full HD)@30fps
Digital Camera Control	Auto/Manual Exposure, Contrast, Brightness, Gamma, Sharpness, High Dynamic Range
Storage / Operating Environment	-20° - +60°C / -5° - +40°C, 20 - 95% RH, non-condensing
Size / Weight: Basics System	400(L) x 295(W) x 385(H) mm / ~9.2 kg.
Size / Weight: ProX System	470(L) x 350(W) x 385(H) mm / ~14 kg. including XY-stage
Antistatic design	ESD protected with GND connection points on stand bracket and XY-stage

Optics: (Side-view BGA lens)

Magnification	~ 300x - 36x on 28" monitor (on-screen magnification at FHD resolution)
Working distance	~ 0.5 - 100 mm (focusing range)
Illumination	Built-in high-power pure white LED light source through microprisms
Footprint of standard size probe	0.85 x 6.6mm on PCB (~ 1mm free area around IC package is required)
Footprint of small size probe	0.70 x 6.0mm on PCB (~ 0.8mm free area around IC package is required)

Optics: (Side-view BGA-XM lens)

Magnification	~ 370x - 55x on 28" monitor (on-screen magnification at FHD resolution)
Working distance	~0.3 - 20 mm (focusing range)
Illumination	Built-in high-power pure white LED light source through microprisms
Footprint of standard size probe	0.85 x 6.6mm on PCB (~ 1mm free area around IC package is required)
Footprint of small size probe	0.70 x 6.0mm on PCB (~ 0.8mm free area around IC package is required)

Optics: (Top-view 8-80x lens)

Lens system	~ 8x - 80x on 24" monitor (on-screen magnification)
Working distance	~ 10 - 150 mm
Illumination	Built-in pure white LED ring-light with holographic diffuser
Size	φ29 x 36 (L) mm

Ordering numbers systems:

Inspectis BGA Inspection System, ProX	BGA-002
Inspectis BGA Inspection System, Basics	BGA-001
Inspectis BGA Inspection System, Light	BGA-003

Ordering numbers accessories:

Inspectis Interchangeable 90° side-view standard BGA inspection lens	BGA-004
Inspectis Interchangeable 90° side-view standard BGA inspection lens, XM	BGA-004-XM
Inspectis Interchangeable 90° side-view small size BGA inspection lens	BGA-005
Inspectis Interchangeable 90° side-view small size BGA inspection lens, XM	BGA-005-XM
Inspectis Interchangeable 90° side-view standard probe (Spare part)	BGA-006
Inspectis Interchangeable 90° side-view standard probe, XM (Spare part)	BGA-006-XM
Inspectis Interchangeable 90° side-view small size probe (Spare part)	BGA-007
Inspectis Interchangeable 90° side-view small size probe XM (Spare part)	BGA-007-XM
Inspectis Interchangeable 8-80x top-view varifocal lens	DM-010
Inspectis fiberoptics brush-light probe (spare part)	BGA-014
Inspectis Stand with Rack&Pinion, soft-touch and pivoting bracket for BGA microscope, XL size	BGA-015
Inspectis Precision XY-stage with antistatic mat and magnetic pegs	DM-012
Inspectis Bench-top Holder for Digital Microscope	DM-036
Notebook or PC, Win10/11, EN, Turn-key with INSPECTIS© software	DM-038
Inspectis Flight Case with foam inlay for BGA ProX inspection system equipment	BGA-017
Inspectis Aluminium Carrying Case for digital microscope, BGA lens and illumination	BGA-018

Performance

The Inspectis visual inspection systems feature cutting edge digital optical camera technology equipped with high resolution lens and pre-calibrated optics. We design, manufacture, and deliver carefully specified optical systems with outstanding performance made from durable high-quality materials to make them fit for purpose with a long life in real working environments.

Quality

Our quality management system is certified to ISO 13485:2016 and ISO 9001:2015, and designed to ensure that all products are fit for their intended purpose, meet the required specifications for quality and safety and comply with regulatory requirements and marketing authorisation.

Support

We are committed to being your strategic partner for digital optical inspection systems and be recognized as the technology leader that provides the highest standards of pre and after sales support. From the moment you engage with us and order an Inspectis product, you can be confident of receiving the best possible assistance including product training, software upgrades and help in the unlikely event of something going wrong.



Reseller:

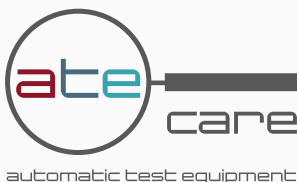

Germany
ATÉcare Service GmbH & Co. KG
Kirchbergstrasse 21
D - 86551 Aichach

+49 8131 318 575 120
info@atecare.com

Switzerland
ATÉcare Alexander Hoertner
Friedhofweg 5
CH - 9434 Au SG

+41 71 740 10 90
info@atecare.net

www.atecare.de

 **INSPECTIS**

Quality of Inspection

Inspectis Optical Systems
Stockholm, Sweden

www.inspect-is.com
info@inspect-is.com